

EDISON PARTY SYSTEM 1240MAX

PROFESSIONAL



Massive Giga Sound Home Audio System
MAXI – HIFI System Composed of 3 Element's
Ideal for DJ, Mobile Disco and Karaoke



54.1"



6.9"



18.1"



- ◆ HQ Class D Amplifier With/ X Drive 1500 PMPO Watts
- ◆ HQ Bluetooth 5.0 Wireless Audio
- ◆ DVD/CD Player
- ◆ Optical & Coaxial Output
- ◆ Professional Loudspeakers
- ◆ Protective perforated steel grille
- ◆ Subwoofer 10" (1),
- ◆ Subwoofer [Lighting Brilliant RGB LED Light Rings](#),
- ◆ Satellite - 3" Mid-Range (2), Tweeter (1)
- ◆ [Satellite LED Animation](#)
- ◆ Audio Control
 - ◆ Volume,
 - ◆ Microphone Volume & Echo Function
 - ◆ Bass & Treble
- ◆ USB In
- ◆ AUX In (RCA)
- ◆ Line Out (RCA)
- ◆ Microphone 6.35mm Input Jacks (2)
- ◆ Headphone Jack (1)
- ◆ Remote Control
- ◆ Professional Karaoke

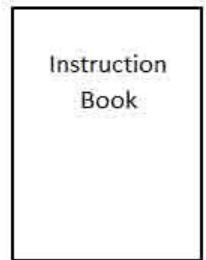

EDISON PARTY SYSTEM 1240MAX

PROFESSIONAL



Massive Giga Sound Home Audio System
MAXI – HIFI System Composed of 3 Element's
Ideal for DJ, Mobile Disco and Karaoke



- 1 Multi Function
- 2 Standby
- 3 Play/Pause
- 4 Menu
- 5 Next
- 6 Input
- 7 LED Display
- 8 Mute
- 9 Volume
- 10 Compartment Door
- 11 Previous
- 12 USB Jack
- 13 Open/Close
- 14 Microphone 1
- 15 Microphone 2
- 16 Headphone

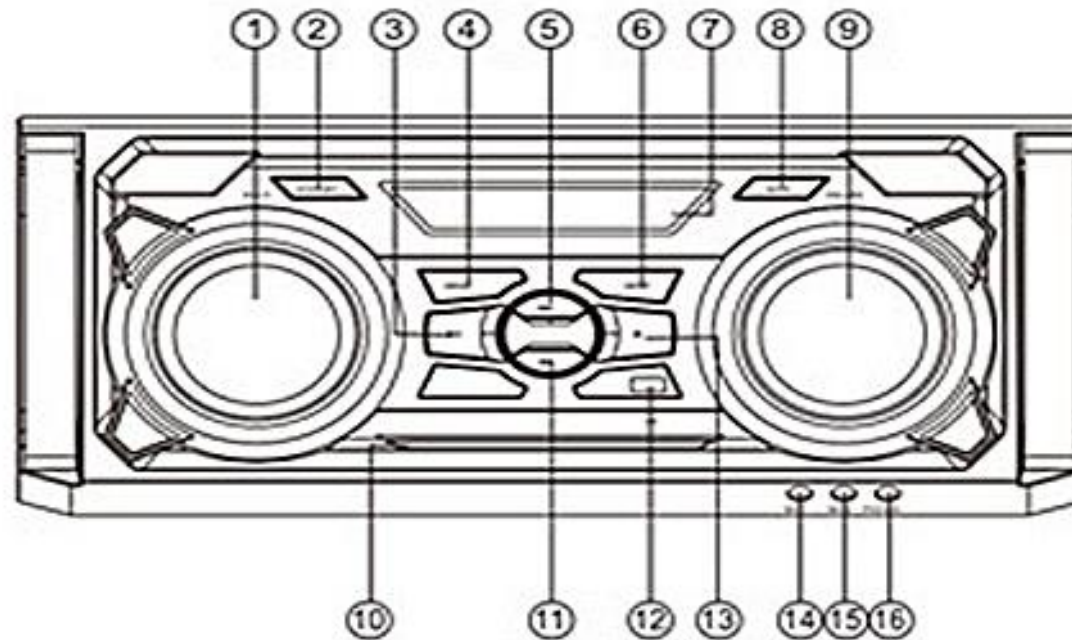

- 1 Speaker Right
- 2 Speaker Left
- 3 Audio Line Out
- 4 AUX Input
- 5 FM Antenna
- 6 HDMI
- 7 Microphone Left
- 8 Microphone Right
- 9 Component
- 10 S-Video
- 11 Optical
- 12 Audio In (Optical/Coax 1-2)
- 13 Power On/Off
- 14 AC Input

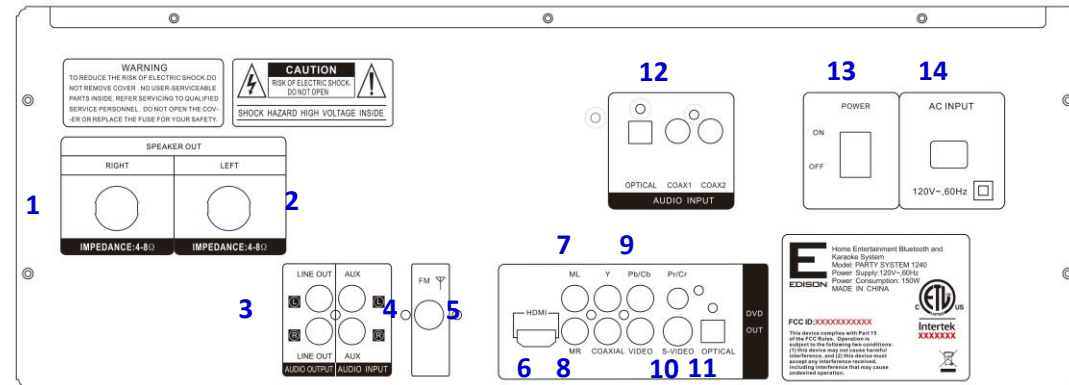

EDISON PARTY SYSTEM 1240MAX

Massive Giga Sound Home Audio System
 MAXI – HIFI System Composed of 3 Element's
 Ideal for DJ, Mobile Disco and Karaoke



PROFESSIONAL



- 1 Mute
- 2 Standby
- 3 USB
- 4 Bluetooth
- 5 AUX
- 6 Line
- 7 Microphone Volume
- 8 X Drive
- 9 Microphone Echo
- 10 Light
- 11 Repeat
- 12 Volume
- 13 Next
- 14 B. Ward
- 15 Treble +
- 16 Previous
- 17 Treble -
- 18 Number Button
- 19 Channel -
- 20 Channel +

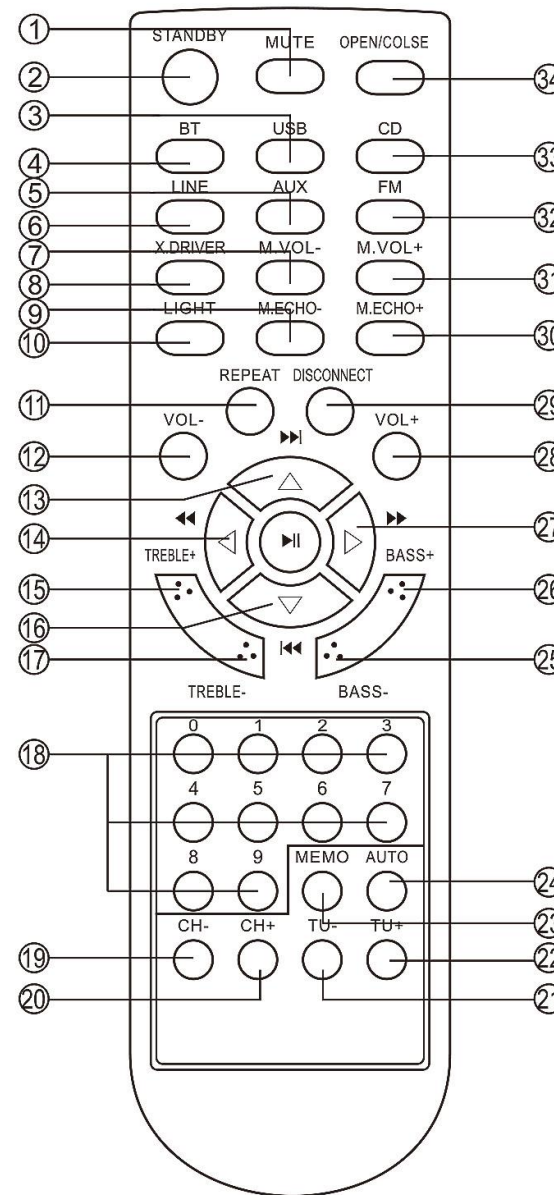

- 34 Open/Close
- 33 CD
- 32 FM
- 31 Microphone Echo -
- 30 Microphone Echo +
- 29 Disconnect
- 28 Volume +
- 27 F. Ward
- 26 Bass +
- 25 Bass -
- 24 Auto
- 23 Memo
- 22 FM Tuner +
- 21 FM Tuner -

EDISON PARTY SYSTEM 1240MAX

Massive Giga Sound Home Audio System
 MAXI – HIFI System Composed of 3 Element's
 Ideal for DJ, Mobile Disco and Karaoke



Receiver Carton

- ◆ Dims 20.1" W 13.3" D x 9.1" H
- ◆ Weight.11.7lbs.
- ◆ Cube (cu/ft) 1.4CBM

Party System 1240 Amplifier carton size: 511x337x230mm(one amplifier in carton)

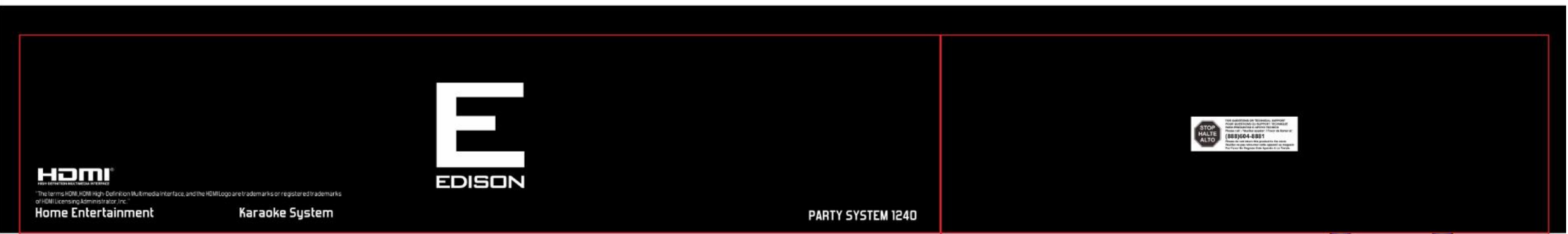

HDMI
 Home Entertainment Karaoke System

PARTY SYSTEM 1240

1600 Watts

10" SPEAKER PARTY LIGHT TOWER

HDMI

USB DVD

LED RING

BOX 1/2



PARTY SYSTEM 1240
 Home Entertainment Bluetooth and Karaoke System



PARTY SYSTEM 1240

Party System with Receiver and Two Speakers
 IDEAL FOR DJ, MOBILE DISCO AND KARAOKE
 1 AMPLIFIER 2 X150W EQUIPPED:
 DVD player
 USB input
 Wireless Audio Function (BTS.O)
 Optical and Coaxial output
 2 SUBWOOFERS AND 2 SATELLITES
 Subwoofer equipped with a 25cm/10inch boomer
 Satellite equipped with 2 x 3inch/8cm boomers and a 1inch/3cm tweeter
 1500 Watts Peek Power
 Party Lighting on Speakers
 Party Lighting on Tower
 Volume, Bass and Treble settings
 Separate Microphone and Echo Controls
 AUX input (RCA)
 LINE OUTPUT(RCA)
 2 x 6.35mm Micro Jack Inputs
 1x Headphone output
 Wireless remote control
Box Contains:
 Party System 1240 Receiver
 Remote Control
 Operation manual
 FM Antenna



The Bluetooth® word mark and logos are registered trademarks owned by the Bluetooth SIG, Inc. and any use of such marks by Brilite Enterprises is under license. Other trademarks (R) and trade names are those of their respective owners.



EDISON PARTY SYSTEM 1240MAX

Massive Giga Sound Home Audio System
 MAXI – HIFI System Composed of 3 Element's
 Ideal for DJ, Mobile Disco and Karaoke



- ◆ Speaker Carton (1)
- ◆ Dims 30.3" W 21.7" D x 23.4" H
- ◆ Cube (cu/ft) 8.9CBM
- ◆ Weight.92.4lbs.
- ◆ Speaker Quantity (2)

- ◆ Pallet pcs.
- ◆ Container Quantity:
 - ◆ 20'GP 90pcs
 - ◆ 40' 187pcs
 - ◆ 40'HQ 215pcs

Party System 1240 speakers carton size: 770x550x595mm(two speakers in carton)

Home Entertainment

Karaoke System

PARTY SYSTEM 1240

1600
Watts

10" WOOFER

2X3" PARTY LIGHT TOWER TWEETER

HDMI

Bluetooth

USB

DVD

BOX 2 1/2

Bluetooth
 PARTY SYSTEM 1240
 Home Entertainment Bluetooth
 and Karaoke System

PARTY SYSTEM 1240

**Party System with Receiver and Two Speakers
 IDEAL FOR DJ, MOBILE DISCO AND KARAOKE**

1 AMPLIFIER 2 X150W EQUIPPED:
 DVD player
 USB input
 Wireless Audio Function (BT5.0)
 Optical and Coaxial output
 2 SUBWOOFERS AND 2 SATELLITES
 Subwoofer equipped with a 25cm/10inch boomer
 Satellite equipped with 2 x 3inch/8cm boomers and a 1inch/3cm tweeter
 1500 Watts Peak Power
 Party Lighting on Speakers
 Party Lighting on Tower
 Volume, Bass and Treble settings
 Seperate Microphone and Echo Controls
 AUX input (RCA)
 LINE OUTPUT(RCA)
 2 x 6.35mm Micro Jack Inputs
 1x Headphone output
 Wireless remote control

Box Contains:
 Two Speakers

The Bluetooth(R) word mark and logos are registered trademarks owned by the Bluetooth(R)SIG, Inc. and any use of such marks by Britelite Enterprises is under license. Other trademarks(R)and trade names are those of their respective owners.

Designed In America Made in China

EDISON PARTY SYSTEM 1240MAX

Massive Giga Sound Home Audio System
 MAXI – HIFI System Composed of 3 Element's
 Ideal for DJ, Mobile Disco and Karaoke



EDISON
 PROFESSIONAL



SPECIFICATIONS

| <u>AUDIO</u> | |
|--|--|
| Speaker Construction | |
| Power Output | 1,500 Watts PMPO |
| Speaker Unit | 10" Woofers, (2) 3" Mid-Range & 1" Tweeter |
| Resistance | 4 ohms |
| Distortion | 1% |
| Sensitivity | 75 dB |
| Frequency Response | Frequency: 38Hz-20KHz |
| Microphone | Microphone In Jacks 6.35mm (2) (Mic's not inc.) |
| <u>COMPATIBILITY</u> | |
| Bluetooth 5.0 music device (typically found on laptops, smartphones, music players and other wireless enabled devices) | |
| <u>MEASUREMENT</u> | |
| Unit Dims Speaker | 15.1" W x 13.8" L x 54.1" H |
| Unit Dims Receiver | 18.1" W x 10.8" L x 6.9" H |
| Weight | Speaker 44.0lbs each, Receiver 10.8 lbs. |
| <u>INTERNAL POWER SUPPLY</u> | |
| AC 110V 60 HZ | |

FEATURES

1,500 Watts PMPO, 10" Subwoofers (2), 3" Mid Range, (2) 1" Tweeters (1), RGB Illuminated Speakers, Bluetooth 5.0, Play DVD/CD, USB, AUX, FM, Remote, Microphone Input, Microphone not included), Plays Bluetooth, Karaoke, USB, SD, FM, LED VFD Display

ACCESSORY Remote,, Operation Manual, FM Antenna,

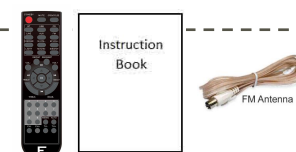

CONTROL & CONNECTION

| | |
|-------------------|-------------------------|
| Main power switch | On / Off (front) |
| Bluetooth Pairing | Controls (front) |
| Volume Control | Controls (front) |
| Volume Control | |
| FM Antenna jack | Back |

STANDARDS & COMPLIANCES

| <u>TERRITORY</u> | <u>AGENCY APPROVAL</u> | <u>RATING LABEL</u> | |
|------------------------|------------------------|--|----------|
| General | ROHS/BQB |  <p>*Other language version of rating label can be produced upon request.</p> | |
| N. America | UL / cUL | | FCC |
| Europe | TUV, BS | | CE / EMC |
| Australia (on request) | SAA | | C-Tick |
| China | CCC | | SRRC |
| Taiwan | BSMI | | NCC |
| Bluetooth | BQB, Product Listing | | |
| UPC # | XXXXXXXXXXXX | | |