

NA30N6555TS

SAMSUNG

30" Gas Cooktop



Signature Features

19K Power Burner

- Powerful burner boils water faster.

Griddle

- Cook breakfast foods, grill sandwiches, or sauté vegetables on the griddle.

LED Illuminated Backlit Knobs

- Visually lets you know your cooktop is on, even at a distance.

Available Colors



Stainless Steel (shown)



Fingerprint Resistant
Black Stainless Steel



19K Power Burner



LED Illuminated Backlit Knobs

Features

- Wi-Fi Connectivity
- Powerful Cooktop
 - Right Front: 13K BTU
 - Left Front: 9.5K BTU
 - Right Rear: 5K BTU
 - Left Rear: 9.5K BTU
 - Center: Dual, 19K BTU
- Cast Iron 3-Piece Grates
- Sealed Burners
- Burner On/Off Monitoring
- ADA Compliant

Convenience

- LP Conversion Kit



ADA Compliant

NA30N6555TS

SAMSUNG

30" Gas Cooktop

Installation Requirements

Countertop cut-out and minimum clearance dimensions:

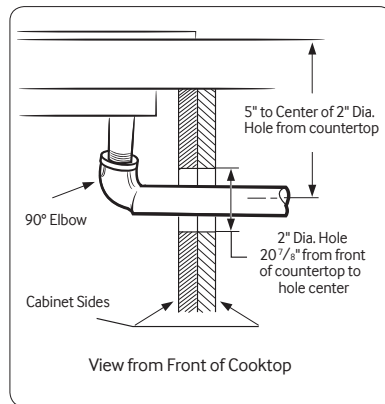
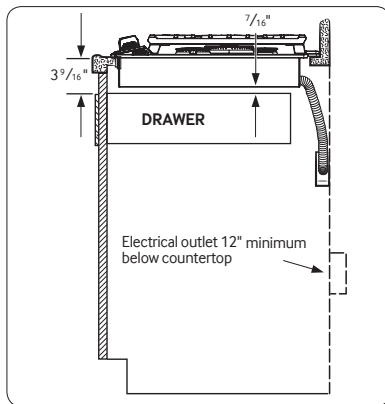
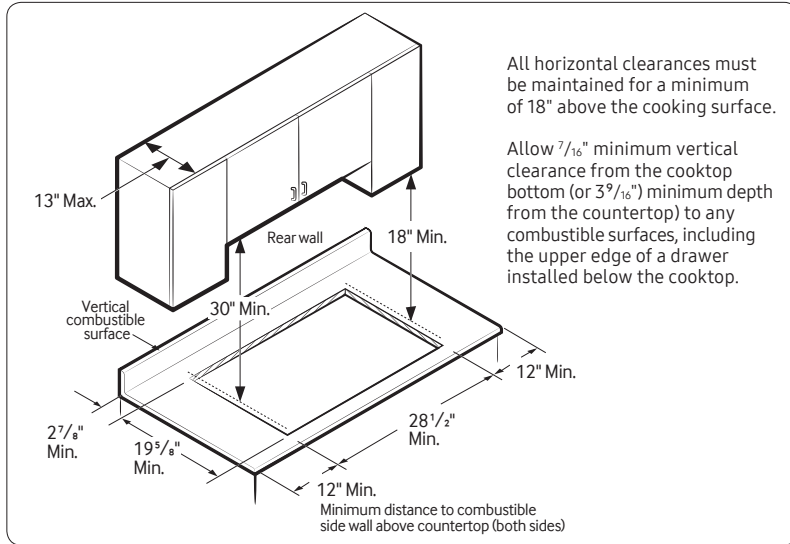

Total Power (BTU)

56K

Power Source

120V / 60 Hz / 1A

Gas Cooktop (BTU)

- Right Front: 13K
- Left Front: 9.5K
- Right Rear: 5K Simmer
- Left Rear: 9.5K
- Center: 19K (Dual)

Warranty

One (1) Year All Parts and Labor

Product Dimensions & Weight (WxHxD)

Outside (Max) Cooktop Dimensions:

30" x $5\frac{41}{72}$ " x $22\frac{1}{3}$ "

Cooktop Cut-Out Dimensions:

$28\frac{1}{2}$ " x $3\frac{1}{8}$ " x $19\frac{5}{8}$ "

Weight: 64.8 lbs. (66.4 lbs. Fingerprint Resistant Black Stainless Steel)

Shipping Dimensions & Weight (WxHxD)

Dimensions: $34\frac{11}{16}$ " x $10\frac{5}{8}$ " x $25\frac{5}{8}$ "

Weight: 73.0 lbs. (74.3 lbs. Fingerprint Resistant Black Stainless Steel)

Color

Stainless Steel

Model

NA30N6555TS

UPC Code

887276281681

Fingerprint Resistant

Black Stainless Steel

NA30N6555TG

887276281674

Installing Over a Single Oven

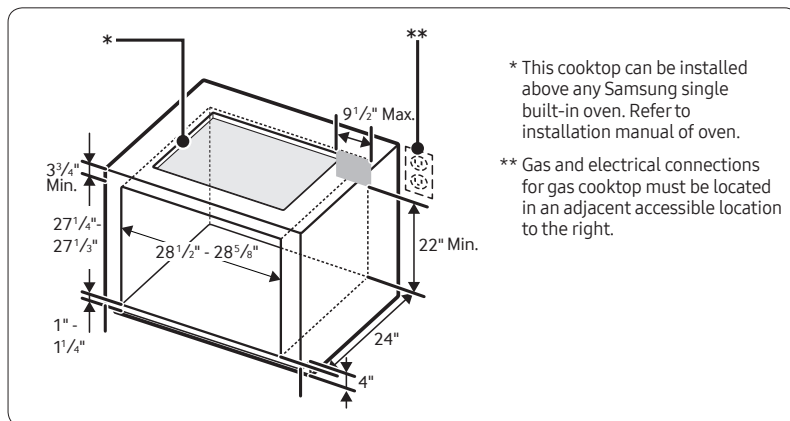

Cooktop Dimensions

